

FORS

Tech

USER MANUAL

KULLANIM KILAVUZU





**USER
MANUAL**

INTRODUCTION

Thank you for choosing and purchasing our Nokta FORS Tech detector.

FORS Tech, developed by Nokta's expert engineering team experienced in metal detection, is a professional metal detector.

Manufacturing high-tech metal detectors since 2001, Nokta Detectors has played a key role in the development of this sector. Nokta Engineering is particularly known for its technological know-how and professional staff.

Seeking to create different kind of technology, Nokta Detectors offers both high-quality products and services to its consumers all around the world. Nokta Detectors has been operating under the principle that environmental and community responsibility, customer satisfaction and insistence on high-quality are of the utmost importance.

Nokta Detectors aims to remain a leading pioneer in its sector, winning the trust of its consumers and always being the preferred choice for metal detecting.



TABLE OF CONTENTS

WARNINGS	3
PARTS and ASSEMBLY	4-5
CORRECT WAY OF HOLDING and SWEEPING	6
BATTERIES	7
DEVICE INTRODUCTION	8-14
CONTROLS	8-9
MAIN SCREEN	9-10
NUMERIC DISPLAY	10
MENU	11-14
SEARCH MODES	15-16
GROUND BALANCE	16-20
SENSITIVITY and THRESHOLD	21
TARGET ID and ID MASKING	22-23
PINPOINT	24
DEPTH INDICATION	25
SWEEP SPEED and TARGET IDENTIFICATION	25
LARGE or SHALLOW TARGETS	25
FALSE SIGNALS and COMMON CAUSES	25
MAGNETIC MINERALIZATION LEVEL	26
HOT ROCKS AND SEARCHING IN ROCKY AREAS	26-27
EFFECTS OF HOT ROCKS IN GROUND TRACKING	27
SEARCHING IN SHALLOW WATER AND ON THE BEACH	27
MESSAGES	28
FACTORY and STARTUP SETTINGS	29
TECHNICAL SPECIFICATIONS	30

WARNINGS

LEGAL WARNINGS

▶ When using the device, comply with all applicable laws and regulations. Do not use the device in private premises, historic sites and military zones. Notify the authorities of any historical or cultural findings.

WARNINGS ABOUT THE DEVICE

- ▶ This is a high-tech electronic device. Do not assemble or use the device before reading the user manual.
- ▶ Do not expose the device or the search coil to very hot or cold conditions for extended periods of time. (Storage Temperature: 0°C (32°F) - 40°C (104°F))
- ▶ Do not immerse the device or its accessories (except the search coil) in water; do not expose them to extreme humid conditions.
- ▶ Protect the device from external impact, especially during transportation.
- ▶ The device can only be opened and repaired by authorized service technicians. The warranty will be voided if the device is opened by you or an unauthorized person.

IMPORTANT

Do not use the device indoors. The device will constantly give target signals inside places like homes where there are many metals present. Use the device outdoors, in open fields.

Do not let another detector or an electromagnetic device come in close proximity (10m (33ft.)) to the device.



IMPORTANT

Do not carry any metal objects while using the device. Keep the device away from your shoes while walking. The device may detect the metals on you or inside your shoes as targets.

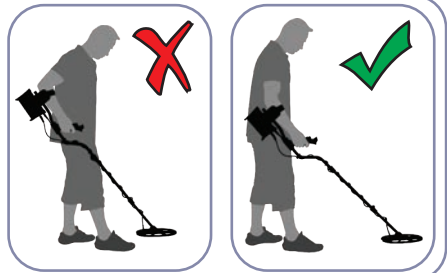

For Consumers within the European Union: Do not dispose of this equipment in general household waste. The crossed wheeled bin symbol on this equipment indicates this unit should not be disposed of in general household waste, but recycled in compliance with local government regulations and environmental requirements.

FCC STATEMENT

This device complies with Part 15 of the FCC Rules. Operation is subject to the following two conditions: (1) this device may not cause harmful interference, and (2) this device must accept any interference received, including interference that may cause undesired operation.



PARTS and ASSEMBLY

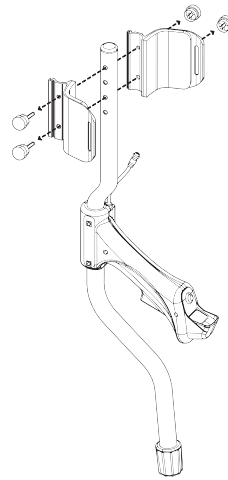
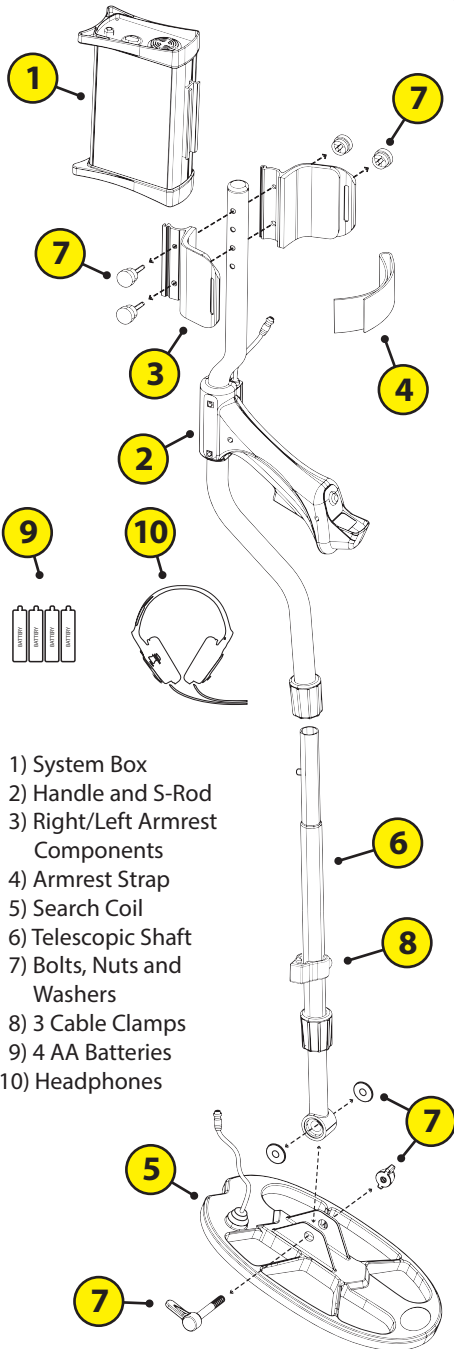

Attach the right/left armrest components to the S-rod with the bolts and nuts as seen in the picture. Do not tighten the nuts but rather leave them loose (these will be tightened after the system box is attached).

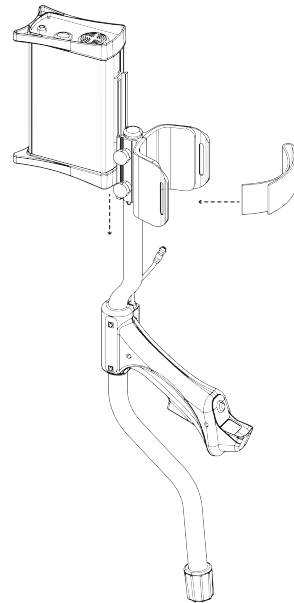

Place the system box on the rail behind the armrest and push forward. Then secure by tightening the nuts. Attach the armrest strap by inserting it through the holes.

PARTS and ASSEMBLY

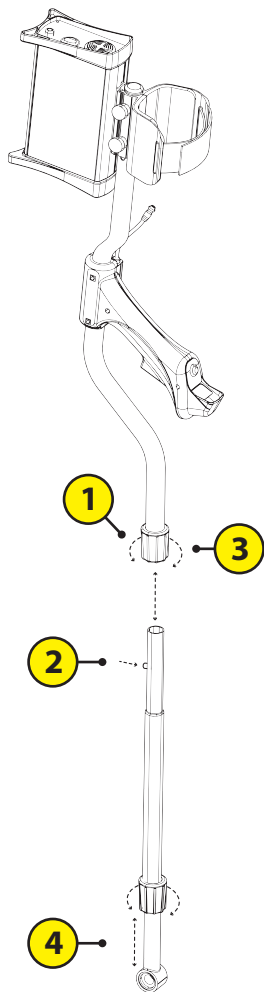

1) To attach the telescopic shaft to the S-rod, first loosen the twist lock. 2) By holding the metal pin pressed, insert the telescopic shaft into the S-rod and click the pin into its hole. 3) Secure it by tightening the twist lock. 4) After adjusting the shaft length to your height, secure by tightening the twist lock.

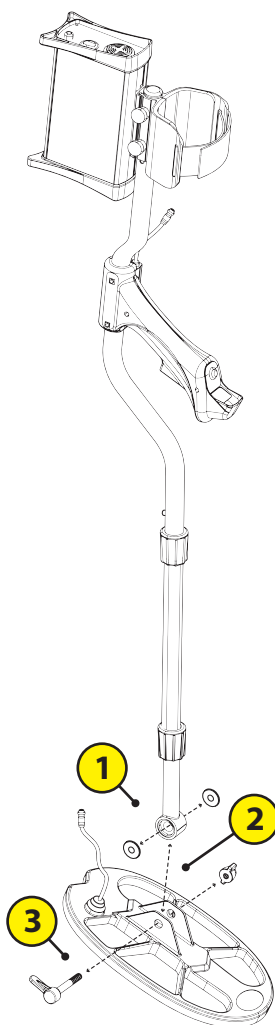

1) Place the washers into the openings at the end of the telescopic shaft. 2) Place the shaft on the coil as shown in the picture. 3) Secure by tightening the bolt and the wingnut.

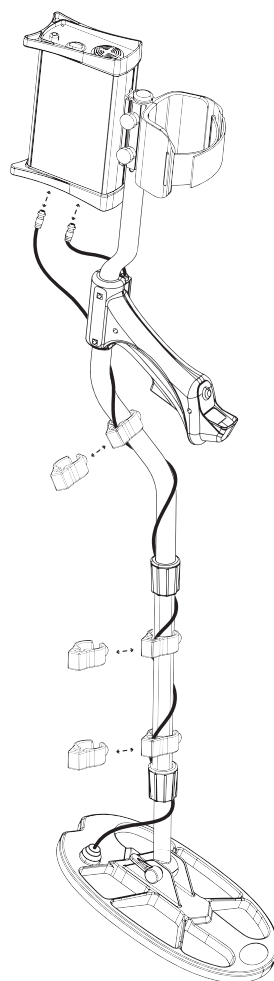

Wrap the coil cable around the shaft all the way up as shown in the picture and after inserting it in the coil input socket underneath the system box, secure it by twisting the connector. Pay attention to not wrap the cable too tight during this step. Insert the handle cable in the socket underneath the system box (HANDLE) and secure it by twisting the connector. Finally, secure the cable by attaching the clamps at 3 different spots.

CORRECT WAY OF HOLDING

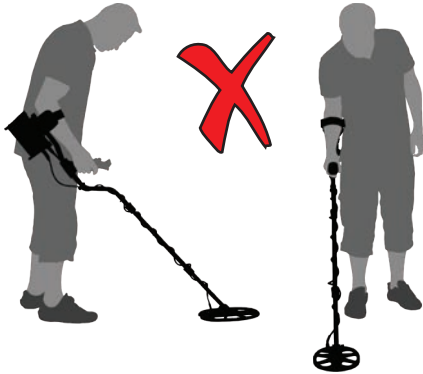

Shaft height is wrong.
It is very important to adjust the shaft to your height correctly to be able to search without discomfort and fatigue.

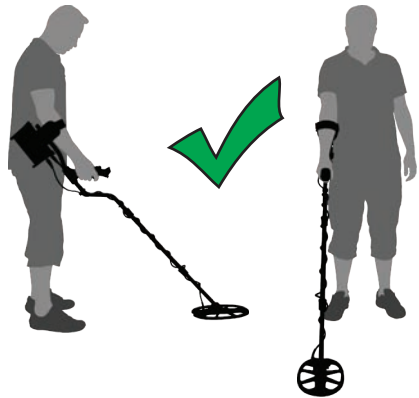

Shaft height is correct.
Adjust the height of the shaft so that you are standing in an upright position, your arm is relaxed and the search coil is approximately 5cm (~2") above the ground.

CORRECT WAY OF SWEEPING

Wrong search coil angle



Wrong search coil angle



Correct search coil angle



Incorrect way of sweeping



It is important to keep the search coil parallel to the ground in order to get accurate results.

Correct way of sweeping

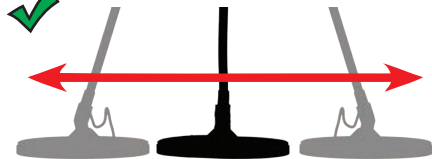

The search coil must be parallel to the ground at all times.

BATTERIES

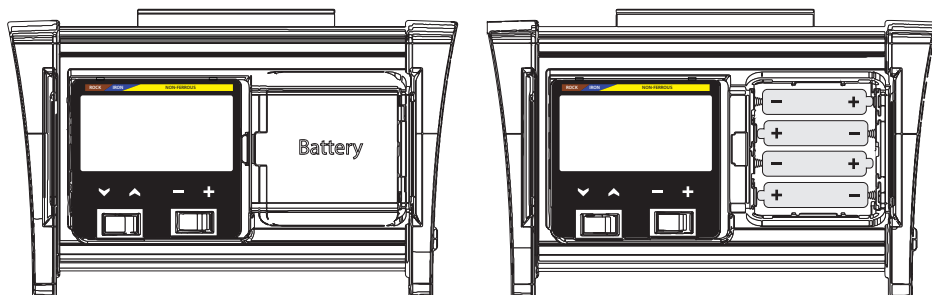

The device comes with 4 AA Alkaline batteries.

Slide and remove the battery compartment cover by pressing the latch. Insert the batteries paying attention to the + (plus) and – (minus) poles.

When batteries are full, they will provide approximately 25-30 hours of use. Different types or brand of batteries may have different lifetimes.

For best performance, using AA Alkaline batteries is recommended. You may also use high quality rechargeable Ni-MH batteries. Rechargeable batteries with higher mAh (capacity) ratings will provide longer run times. Using batteries with minimum 2500mAh is recommended.

LOW BATTERY

The battery icon on the LCD panel indicates the battery life status. In addition, a warning message will appear on the screen when the batteries are low. After the low battery warning, the batteries will run approximately 3-4 more hours. This runtime will vary based on the remaining battery charge. Ni-MH batteries have lower voltage so their remaining runtime will be longer than Alkaline batteries. This does not affect the total runtime.

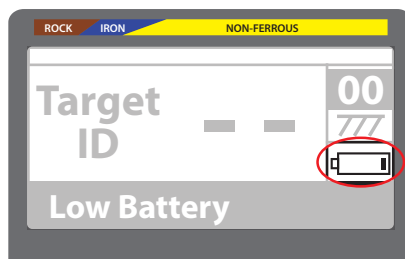
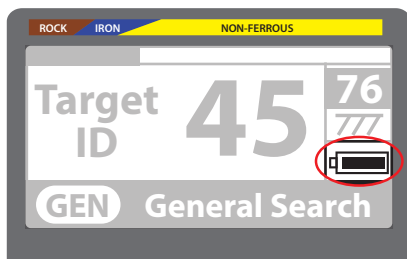

DEVICE INTRODUCTION

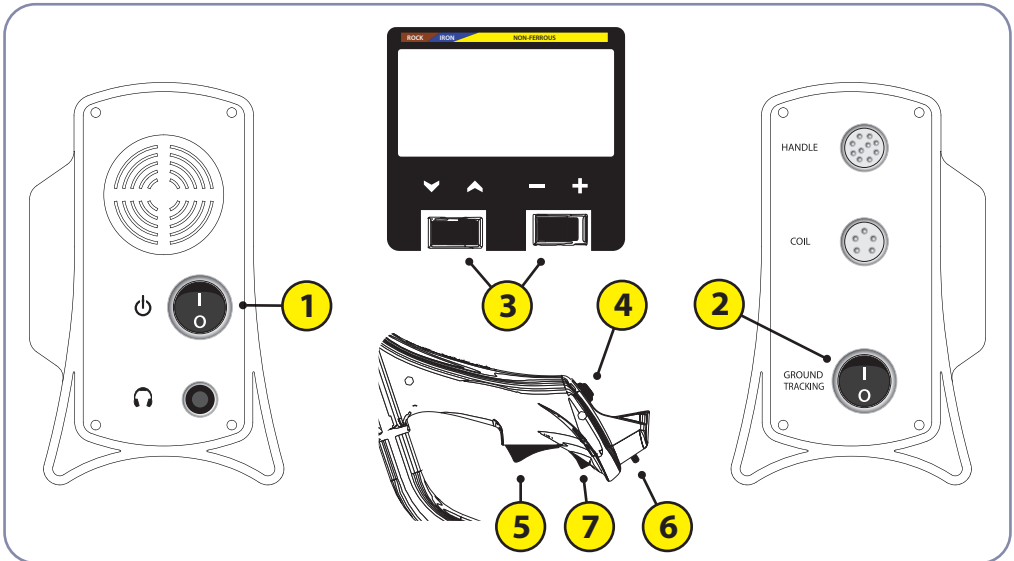

CONTROLS

(1) POWER SWITCH:

To turn on the device, press the power switch to (1) position. The startup tone will be heard and after the FORS Tech logo is displayed for a short period of time, the main screen will come up on the LCD panel.

(2) GROUND TRACKING SWITCH:

When the ground tracking is active (at 1 position), the device will track the changes in ground and automatically adjust the ground balance to suit. The invisible changes in ground affects the detection depth as well as the discrimination ability of the device so you can improve the performance of the device by activating this feature on suitable ground. You can find more details about ground tracking on page 19.

(3) MENU AND SETTINGS SWITCHES:

These switches allow you to access the menu and scroll through options as well as adjust device settings.

On the main screen, you can access the menu by pressing one of the up/down/+/- switches. You can select the menu options with the up and down switch and change the value with the + (plus) and - (minus). Pressing these switches in a specific order will result in "resetting factory settings" or "saving startup settings". You can find more details about this on page 30 under the title FACTORY and STARTUP SETTINGS.

DEVICE INTRODUCTION

If you press and hold any of these switches at startup, system information including software version and the serial number of the device will appear on the screen after the Nokta logo is displayed for a few seconds. This information will stay on the screen as long as you hold the button pressed. Please have this information ready when you contact your dealer regarding your device.

(4) GROUND BALANCE BUTTON:

Allows you to ground balance manually or automatically before or during your search. By keeping this button pressed and pumping the coil, you can quickly ground balance the device at any time. When you press and release the button, you can ground balance manually by changing the ground balance value on the screen. Please read pages 16-20 for more information on ground balance.

(5) PINPOINT SWITCH:

It is used to find the exact location of the target. Pinpointing saves you digging time by narrowing down the location of a buried target. Please refer to PINPOINT section on page 24 for more details.

(6) LED FLASHLIGHT:

Is used for illumination at night or in dark places. The flashlight will not work when the device is off. Having the flashlight on will affect power consumption so we recommend to keep it off when not needed.

(7) LED FLASHLIGHT POWER SWITCH:

Is used to turn on/off the flashlight.

MAIN SCREEN

You can see all the information you need during searching, ground balancing, and pinpointing on the main screen. The information is as follows:

During Searching:

- 1) TARGET ID
- 2) TARGET ID INDICATOR (HORIZONTAL BAR)
- 3) MAGNETIC MINERALIZATION LEVEL
- 4) GROUND TRACKING ON/OFF
- 5) SEARCH MODE or WARNING MESSAGE
- 6) BATTERY LEVEL

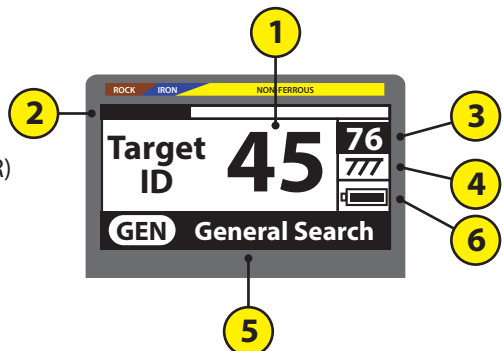

DEVICE INTRODUCTION

During Ground Balancing:

- 1) GROUND BALANCE VALUE
- 2) GROUND BALANCE FINE TUNE VALUE
- 3) SEARCH MODE or WARNING MESSAGE
- 4) GROUND TRACKING ON/OFF
- 5) BATTERY LEVEL

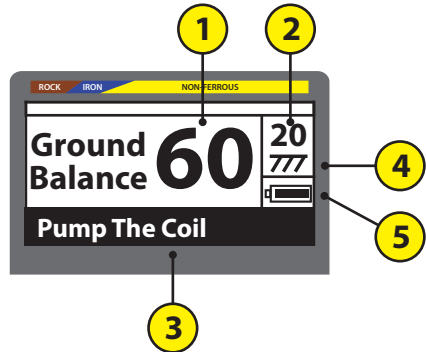

During Pinpointing:

- 1) TARGET DEPTH
- 2) NEGATIVE/POSITIVE BAR INDICATOR
- 3) MAGNETIC MINERALIZATION LEVEL
- 4) GROUND TRACKING ON/OFF
- 5) BATTERY LEVEL

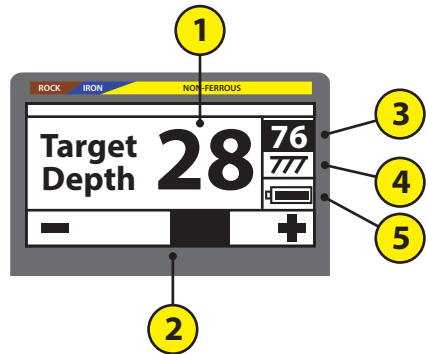

NUMERIC DISPLAY

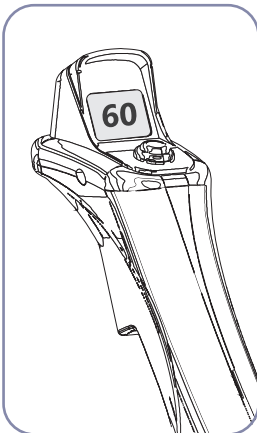

The ground balance value during ground balancing and the target ID during searching instantly appears on the numeric display located on the handle. The estimated target depth also appears on this display during pinpointing.

Therefore, once you adjust your settings on the LCD panel located on the system box, you can follow all the information you need on the numeric display. This way you don't need to go back and check the LCD panel constantly. This provides great comfort during searching.

The numeric display backlight turns on only when a number is displayed to save power.

MENU

The menu screen allows you to access all the FORS Tech settings. You can go to the menu screen by pressing one of the up/down/+/- switches while on the main screen and adjust the settings of the device. Now let's take a look at these settings:

MODE: **MODE** **GEN**

FORS Tech has 4 predefined search modes based on ground conditions and target type. During your search, you can select one of these modes and quickly personalize its settings in the menu if you want to.

The names of the search modes are abbreviated as GEN, DI2, DI3 and COG. Please read the SEARCH MODES section for more details on modes (see pages 15-16).

SENSITIVITY: **SENSITIVITY** **50**

It is the detection depth setting that controls the gain of the device. It is used to eliminate the electromagnetic interference signals received from the surrounding environment as well as ground noise.

Each mode has its own default sensitivity value in the menu. When you change the mode, the sensitivity value preset for that mode is displayed. This does not affect the sensitivity levels set by the user in other modes. For ideal settings and detailed information please refer to the SENSITIVITY and THRESHOLD settings (page 21).

Sensitivity level can be adjusted from 1 to 99. The most ideal sensitivity level for each mode has been preset by the factory. Sensitivity level may be changed manually when needed.

THRESHOLD: **THRESHOLD** **60**

Threshold is used to increase the target signals and thus the detection depth of the device. In General Search mode, it adjusts the audible level of the constant background hum. For more details on threshold, please refer to the SENSITIVITY and THRESHOLD settings (page 21).

ID MASKING: **ID MASKING** **10**

When the search coil passes over a target, if the target signal is strong enough, a 2-digit target ID will be displayed on the numeric display as well as the LCD panel. Target ID ranges from 0 to 99. Target ID is a number produced by the detector based on a target's conductivity and it gives you an idea about what the target may be.

ID Masking is the ability of the detector to ignore (not produce a warning tone or ID) unwanted metals or mineralized rocks.

DEVICE INTRODUCTION

You can customize ID Masking according to your needs. Each mode has its own default ID Masking value in the menu. When you change the mode, the ID Masking value preset for that mode is displayed. This does not affect the ID Masking levels set by the user in other modes. ID Masking is not active in the General Search mode. For detailed information on Target ID and how to use ID Masking, please refer to the section TARGET ID and ID MASKING (pages 22-23).

FREQUENCY: FREQUENCY 03

Changes the operating frequency of the device. It is used to eliminate the electromagnetic interference received from the surrounding environment or another detector operating within the same frequency range. If the device receives a lot of noise when the search coil is held in the air, the cause may be electromagnetic interference or a high sensitivity setting. If you suspect electromagnetic interference, you may change the frequency. There are 5 frequencies in the device. The factory default is 03. Normally, the frequency setting is not enabled and it is grayed out in the menu. To activate it, while holding the pinpoint button pressed, press one of the up/down/+/- switches. Then, you can select the frequency option in the menu and change it.

IMPORTANT! Frequency shifting may affect the performance of the device. Therefore, it is recommended that you do not change the frequency unless necessary and keep it at the factory default.

VOLUME: VOLUME 02

This control allows you to increase or decrease the device's volume based on your preference and environmental conditions. Volume level can be adjusted from 0 to 20. When you turn off and on the device, it will start with the last volume level you chose. This setting is common to all modes; changes will take effect in all modes. Because the volume level affects power consumption, we recommend you not to increase it more than necessary.

tone: TONE 01

It allows you to change the audio frequency of the threshold and target warning tones according to your preference. There are 5 different audio frequencies ranging from treble to bass. Tone change does not affect the iron tone. It is active in the General Search, DI2 and COG modes. It is inactive in the Discrimination 3 (DI3) mode. It changes the audio frequency of the threshold sound in the General Search mode and the gold/non-ferrous metal sound in the DI2 and COG modes.

BRIGHTNESS: BRIGHTNESS 08

This control allows you to adjust the backlight level of the numeric display on the handle and the LCD panel on the system box based on your preference and environmental conditions. Brightness level can be adjusted from 0 to 20. This setting is common to both displays; changes will take effect on both. When you change the brightness level in the menu, the backlight will turn on the numeric display and number "88" will appear for easy adjustment. When you turn off and on the device, it will start with the last brightness level you chose. This setting is common to all modes; changes will take effect in all modes.

DEVICE INTRODUCTION

The brightness level of the LCD panel on the system box affects power consumption a lot. Therefore, the backlight illuminates during menu access and ground balancing. It does not illuminate during searching or target detection. On the other hand, the brightness level of the numeric display on the handle affects power consumption relatively less. It illuminates during target detection and pinpointing. Especially if you are using the menu frequently, we recommend that you choose the minimum brightness level that you can see in for longer battery life.

VIBRATION: VIBRATION 02

This feature enables the device to provide vibration feedback as well as audio when a target is detected during searching. Vibration can be used alone without audio feedback. When the volume is turned off, target detection will be conveyed to the user by vibration.

Vibration level can be adjusted from 0 to 5. When set to 0, vibration will be deactivated. By adjusting the vibration level between 1 and 5, you can change the speed of vibration, in other words the effect felt by the user, in all search modes. At level 1, the device will only vibrate on more definite targets (shallow) and the target's vibration signal will be longer. At the maximum level 5, the device will vibrate with smaller target signals (deeper) and the vibration signals will be shorter. The speed of vibration will vary based on target depth and sweep speed. When you turn off and on the device, it will start with the last vibration level you chose. This setting is common to all modes; changes will take effect in all modes.

The speed of vibration is fixed in the pinpointing mode; it cannot be adjusted. In other words, there is no difference between 1 and 5. But when it is set to 0, it will be off just like in the search modes. In the pinpointing mode, the speed of vibration will increase as you get closer to the center of target response and it will reach its maximum level at the center.

The vibration feature of FORS Tech has been developed with hearing impaired people in mind. The hearing impaired users have to follow the screen constantly and this can be tough during searching. There is a good chance that they will miss a target when they are not looking at the screen. Vibration feature enables the hearing impaired users to metal detect more conveniently.

LANGUAGE: LANGUAGE EN

Is used to change the language of the device. The FORS Tech menus can be viewed in 10 languages. At initial startup, the factory default language will be displayed. The user can change the language in the menu. When you turn off and on the device, it will start with the last language you selected.

Language is placed as the last option in the menu so it is easy to find in case the language is changed to a foreign language by mistake. For languages written from right to left, the screen layout is also designed that way.

DEVICE INTRODUCTION

IMPORTANT DETAILS ABOUT MENU USAGE:

- * If no button is pressed for a few seconds after accessing the menu, the device will go back to the main screen. If you do not want to wait, you can press and release the pinpoint button once to go to the main screen as well.
- * Do not turn off the device while the menu screen is displayed. If you turn off the device while in the menu and made changes in the personal settings (volume, tone, brightness, vibration and language) the changes will not be saved.
- * You do not need to confirm or exit the menu to save the changes. New values will take effect immediately.
- * When you select the "brightness" option in the menu, the backlight will turn on and number "88" will appear on the numeric display. This way, the user can see the correct brightness level on screen and adjust it accordingly.
- * If you change the language of the device to a foreign language by mistake, the text on screen may make no sense for you. Therefore, language is placed as the last option in the menu. In such a case, go to the last option and select your own language.
- * When you press and hold the menu switches, the menu options and values will change more rapidly.
- * Disabled menu options (that cannot be changed by the user) will appear grayed out. The disabled option may be active in another mode. (For example; ID Masking appears disabled in the General Search mode but active in other modes)

SEARCH MODES

GENERAL SEARCH MODE (GEN):

Sometimes referred to as the "All Metal" mode, this is the deepest mode of the device. Different than the other modes, this mode has a constant threshold sound in the background that enables the user to use his/her own judgment.

In the General Search mode, the device will detect all targets (metal, high mineralized rocks etc.) without discrimination. The ID of the detected target will be displayed on the screen (except for negative rocks) and the device will emit the same tone for all targets. The audio warning tone will increase in pitch as the coil approaches the target.

In this mode, the sensitivity and threshold settings are preset by the factory for best performance on most soil types. If you want, you can change these settings based on ground conditions in your search field.

ID Masking is not available in this mode so it is disabled in the menu.

We recommend using the General Search mode when discrimination is not necessary and not using it in heavy trash areas or areas containing many hot rocks.

DISCRIMINATION MODES (DI2, DI3 and COG):

Different than the General Search mode, there is no threshold in these modes and the device emits a warning tone only when a target is detected. If the sensitivity level is not set properly, you can hear a crackling sound in these modes. Therefore, the sensitivity should be adjusted to a level that the device is silent when there is no metal present.

Discrimination modes have some common features but they have slight behavioral differences. ID Masking is a common feature, used frequently in these modes. ID Masking values are preset by the factory for these 3 modes. If you want, you can change these values based on field and ground conditions.

DISCRIMINATION 2 (DI2):

It is the 2-tone and the deepest one among discrimination modes. It provides good results especially in clean fields without much trash metals. In rocky or trashy fields, however, you can perform deeper searches by using the ID masking feature and sweeping the search coil more slowly (about one full right & left pass in 1 second). ID Masking factory setting is 10. You can change this value according to the ID of the target.

In the DI2 mode, the device will produce a low tone for iron and for all other metals, it will produce a single tone just like in the General Search Mode, which increases in pitch as the coil approaches the target.

To get familiar with the warning audio tones, we recommend you to test the device with different metals and rocks before you use it in the field.

DISCRIMINATION 3 (DI3):

This is the 3-tone discrimination mode. The device will emit a low grunt tone for iron, a low tone for gold and foil, and a high tone for non-ferrous metals such as silver, brass and copper. This mode is ideal to use in fields with different types of metals enabling you to search faster with audio discrimination. Provides good results in trashy fields.

SEARCH MODES

If you want, you can use the ID Masking to ignore unwanted targets. The ID Masking default value is set to 10. We recommend you to change this value according to the type of target.

CONDUCTIVE GROUND (COG):

This is the special mode of FORS Tech designed for conductive ground (wet beach sand, alkali sand etc.). What is special about this mode is that it will not react to iron or similar targets within the same range and that the device will ground balance easily on all types of ground. The reason for this is that while the device can ground balance automatically between 40-90 in the other discrimination modes, it can ground balance between 0-90 in this mode. This enables you to easily ground balance the device on conductive ground where normally you can hardly ground balance or cannot ground balance it at all.

Just like in the DI2 mode, in the COG mode, the device will produce a low tone for iron and a single tone for all other metals which increases in pitch as the coil approaches the target.

Different than the other modes, the ID Masking is preset to 40 to eliminate ferrous metals or ground effects due to iron mineralization. If you are searching for ferrous targets, you can use another mode or set the ID Masking value below 40.

Salty water or alkali ground are highly conductive due to high ionization and they create iron effects on detectors. These effects can easily impair a detector's capability of searching and detecting metals. Existence of iron elimination feature in a detector can improve the situation but may not be sufficient.

FORS Tech Conductive Ground mode eliminates these effects and ground noise. What you need to pay attention to when metal detecting on conductive ground are further explained under SEARCHING IN SHALLOW WATER and ON THE BEACH (see page 27).

GROUND BALANCE

Metal detectors work on the principle of conductivity and all metals are conductive. On the other hand, soil itself has a certain degree of conductive property. Under certain conditions, the conductivity level of the soil may be very high. Soil and rocks have magnetic properties as well as conductivity. For this reason, when searching in soil and between rocks, in order for the detector not to give a target signal for the soil, the detector should be able to eliminate the soil and minimize the effects of rocks while still detecting real targets. Otherwise, false signals and noise may mislead the user and make it impossible to find the target. The purpose of ground balancing is to eliminate these false signals and noise.

When you sweep the search coil over the ground, you can see whether the ground balance is adjusted properly or not. However, if the signals and noise continue when the coil is raised up, you must consider the possibility of the electromagnetic waves in the surrounding environment. Electromagnetic waves may result from power lines or from the operation of electrical devices, radars, wireless radios, and even TVs. In such a case, first make sure that the device is silent by making the sensitivity and threshold adjustments and then ground balance.

GROUND BALANCE

One of the following may happen as a result of improper ground balancing:

- The device gives a signal when the coil is swept over the ground where there is no target.
- The device is silent but loses detection depth for certain metals.
- The device receives target-like signals next to holes and dips.

The above mentioned situations do not only occur as a result of improper ground balance adjustment. However, before looking into other reasons you must be sure that the ground balance is correctly adjusted.

Ground balance value is common to all modes; changes will take effect in all modes. When using the automatic ground balance or ground tracking, this setting is adjusted automatically.

Ground balance can be done in three ways in FORS Tech: Automatic, Manual or Ground Tracking.

During automatic or manual ground balancing, when you press the ground balance button, no matter what mode you are using, the device will unnoticeably revert to the General Search mode and the audible tones will be heard accordingly.

AUTOMATIC GROUND BALANCE:

Automatic ground balance is done the same way in all modes:

1. Find a spot on the ground where there is no metal.
2. Press and hold the ground balance button and pump the search coil up and down from about 15-20 cm (~6"- 8") above the ground down to 3 cm (~1") off the ground.
3. Continue until you hear the beep indicating that the ground balancing is completed. Based on ground conditions, it usually takes about 1-4 pumps for the ground balance to be completed.
4. Once the ground balance is done, the ground balance value will appear on the LCD panel as well as the numeric display on the handle. If you continue to press and hold the ground balance button, the device will keep on ground balancing and beeping. To make sure that the ground balance adjustment is correct, please repeat the process 2 or 3 times and each time check the value on the display. The difference between the values should not be greater than 1 or 2 numbers.
5. If you cannot ground balance, meaning you don't hear the beep, either the ground is very conductive or not mineralized or there must be a buried metal object underneath the coil. In such a case, move to another location and re-ground balance. If you still cannot succeed, try manual ground balancing.

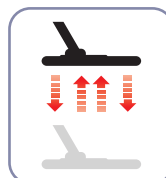
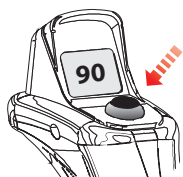

GROUND BALANCE

After the ground balance button is released, the device will work in the General Search mode and the ground balance value will remain on screen for a while. (If you do not want to wait for this period you can go to the main screen by pressing and releasing the pinpoint button once). This gives you the opportunity of fine tuning the automatic ground balance value. Please refer to the following MANUAL GROUND BALANCE section for more details.

MANUAL GROUND BALANCE:

It is the process where you set the ground balance value manually. Because it is more time consuming, it is not preferred by most users. However, it becomes useful when ground balance cannot be achieved by other methods or when you need to fine tune the automatic ground balance value.

FORS Tech is designed in a way that you can easily auto ground balance it on all types of ground. Therefore, we recommend that you use automatic ground balance at start up. However, some soils are not suitable for automatic ground balancing (except for the COG mode). For example; wet beach sand, soils containing alkali or salty water, trashy areas, plowed lands, highly mineralized ground or ground with very low mineralization are not suitable for automatic ground balancing. We recommend you to manually ground balance in such areas for your convenience. Manual ground balance requires experience acquired with some practice.

To ground balance manually:

1. Find a spot on the ground where there is no metal.
2. Select the General Search Mode. Pump the search coil up and down from about 15-20 cm (~6"- 8") above the ground down to 3 cm (~1") off the ground.

If the sound gets louder as you lift the search coil off the ground, it means that the ground balance value is too low. In other words, the ground is negative and you need to increase the ground balance setting with the up switch. On the contrary, if the sound gets louder as you lower the search coil to the ground, it means that the ground balance value is too high. In other words, the ground is positive and you need to lower the ground balance setting with the down switch.

3. Press and release the ground balance button once. The ground balance value will appear on the LCD panel and will stay on screen for a while. If the screen changes, you can press the ground balance button again.



Manual ground balance ranges from 0-99. However each number includes 5 steps used for fine tuning and these steps are shown on the LCD panel over the **777** symbol and in multiples of 20. For example; the ground balance value on the screen to the side is 60.20.

To increase the ground balance setting, press the up switch and to decrease it, press the down switch. If you press the switch one by one, the values will change one by one as well. If you hold the switch pressed, the values will change rapidly.

GROUND BALANCE

4. Continue the above process until the sound is eliminated. If the sound is not completely eliminated, then you can fine tune.

For fine tuning, follow the numbers above the **777** symbol and use the + and - switches.

The sound may not be eliminated completely on some types of ground although you have fine tuned. In such a case, to determine whether you have successfully ground balanced or not, listen to the audio feedback when lowering the search coil to the ground and when lifting it off the ground. If both sound the same, it means that the ground balance is adjusted properly.

After a while the ground balance is completed, the device will switch to the main screen automatically. If you do not want to wait for this period you can go to the main screen by pressing and releasing the pinpoint button once.

GROUND TRACKING:

With this feature, the user does not need to make any adjustments. Ground Tracking can be activated by turning the Ground Tracking switch to 1 position. The Ground Tracking icon (**777**) on the LCD panel starts blinking. As long as the search coil is swept over the ground, the device updates the ground balance setting. It does not provide the user any kind of feedback (such as the ground balance value or the beep sound in the auto ground balance).

When Ground Tracking is active, the device may emit a loud audible signal if the ground conditions change (for example a hot rock) or if a target is encountered. In such a case, sweep the search coil a few times over the spot where you receive the signal. If the sound continues and the device gives an ID, there is a high chance that it is a target. If the sound gets weaker or disappears after a few sweeps, it means that that the device gave a signal for the ground change or the hot rocks.

For better performance, we recommend you to use Ground Tracking in the General Search mode and not in the discrimination (DI2, DI3 and COG) modes.

Ground Tracking is suitable for fields with different types of soils or where hot rocks are scattered around a large area and not condensed. If you use Ground Tracking in areas where hot rocks are intensely present, the device may not be able to eliminate these high mineralized rocks or you may miss the smaller or deeper metals.

IMPORTANT! When air testing, be sure that Ground Tracking is off. Otherwise, the device will try to ground balance over the target and lose depth.

GROUND BALANCE

GROUND BALANCE VALUE:

The ground balance value indicates the type of ground. Some typical ground types are as follows:

0-25	Wet salt water or wet alkali soils
25-50	Wet salt water and wet alkali soils covered with dry layers
50-70	Regular, low-quality soils
70-90	Highly magnetic soils, magnetite or maghemite and similar highly mineralized soils, black sand

IMPORTANT DETAILS ABOUT GROUND BALANCE:

When the device is turned on, the ground balance value is preset to 90. Automatic ground balancing value ranges from 40-90 in all modes and from 0-90 in COG mode. If the ground mineralization is too low, the automatic ground balance may not work except for the COG mode.

You can test the accuracy of the ground balance setting in the pinpointing mode as well. Once the ground balance is done, lower the search coil to the ground. If the device receives no signal or a very weak one as the search coil approaches the ground, it means that the ground balancing was successful. On the contrary, if the device receives noise as the search coil approaches the ground, it means that the ground balance has failed. In this case, change your location and try re-ground balancing. If you still cannot ground balance, you need to continue searching without ground balance. Turn off and on the device again and start searching without ground balancing. If you receive noise when you sweep the coil over the ground, set the search mode to DI3 or DI2 (adjust sensitivity accordingly) or to COG mode if you are on the beach and increase the ID Masking to a level where the noise is eliminated. On the other hand, because the ID Masking is not active in the General Search, if you cannot reduce the noise, you cannot continue searching either.

Once the ground balance is set, it will remain satisfactory for a long time in most areas. However, in areas where the soil has been disturbed by digging or filling up, or in geologically complex areas, you may have to ground balance frequently to accommodate changing ground conditions.

SENSITIVITY and THRESHOLD

Adjusting these two settings correctly is critical for the device to work at its best performance and without noise. It is possible to obtain an average performance with the startup settings. However, to be able to have better detection depth in clean areas or to be able to search in tough ground conditions, these two settings must be adjusted properly.

Sensitivity and Threshold in General Search Mode:

In the General Search mode, a constant background hum is heard during searching. The loudness of this hum directly impacts the detection depth of smaller and deeper targets and it is adjusted by the threshold setting. If the threshold is set too high, the target signal may not be heard. On the contrary, if it is too low, you give up the depth advantage this setting offers. In other words, weak signals of smaller or deeper targets may be missed. Threshold setting comes with the default value at each startup (not with the last adjusted value). It is recommended for average users to leave this setting at its default value and for experienced users to adjust to the highest level where they can still hear the weak target signals.

In the General Search mode, although the sensitivity setting seems like it is behaving similarly to the threshold, it actually causes an increase or decrease in the popping sounds and false signals. It is important to set the sensitivity setting to the highest level possible where no major popping sounds are heard. For example; if the noise level is suitable for searching and is the same at sensitivity levels 20 and 50, then 50 should be preferred. Using the factory default levels will be a good starting point until you get familiar and experienced with the device.

If the device is stable but too noisy, the threshold setting should be decreased. However, if it sounds erratic and there is too much popping, the sensitivity setting should be lowered.

Sensitivity in Discrimination Modes:

Because there is no threshold in discrimination modes, by using the sensitivity setting alone, you can increase the detection depth or enable the device to run without noise in different fields.

To adjust the sensitivity setting in discrimination modes, ground balance first with the sensitivity set at its default value. After the ground balance is completed, hold the search coil still or sweep above the ground at the search height. If the device receives noise, lower the sensitivity. If the device receives no noise (when checking this, please be sure that the ID Masking is also at its factory default value), you can increase the sensitivity setting gradually to the highest level where there are no popping sounds. During searching, if the device starts receiving noise, lower sensitivity gradually.

TARGET ID and ID MASKING

As mentioned before, Target ID is a 2-digit number produced by the detector and it gives you an idea about what the target may be. The number is displayed both on the LCD panel and the numeric display on the handle.

Under certain conditions, the device may generate multiple IDs for the same target. There may be a few reasons for this: target orientation, target depth, purity of metal, corrosion, ground mineralization etc. Based on these factors, even the sweep direction may cause the device to generate multiple IDs.

On the other hand, the device may not give any ID under some circumstances. For the device to generate an ID, the target signal must be strong enough for signal processing. Therefore, although it may detect very deep or small targets, it may not be able to generate an ID.

In addition to the target ID, there is a color scale at the top of the LCD panel which represents rocks, iron and metals encountered in the field. When a target is detected, simultaneously with the display of the target ID, the target ID indicator (horizontal bar) shows the color range corresponding to the detected target.

What you should keep in mind is that the target ID and colors are estimated values and there is no way of knowing for sure what's buried other than to dig it up.

Probable IDs and ranges of some targets are shown in the table below:

Silver and lead	80-95
Brass and copper	90-97
Aluminum	93-97
Hot rocks	0-5 / 95-99
Iron rocks	5-25
Salty and alkali soils	25-35
Iron	5-25

TARGET ID and ID MASKING

ROCK

IRON

NON-FERROUS

Brown Area: Hot rocks

Blue Area: Ferrous metals, iron rocks, salty and alkali soils

Yellow Area: Copper, brass, aluminum, silver, gold, some hot rocks etc.

This data may vary based on the field conditions.

It may take some time and experience to utilize the Target ID feature in your search area because Target IDs as well as the depths the IDs are generated by different brands and models of detectors are also different.

As mentioned before, ID Masking is the ability of the device to ignore (not produce a warning tone or ID) unwanted targets. ID Masking is not active in the General Search mode. ID Masking values of the discrimination modes are preset by the factory. If you want, you can change the ID Masking values in the menu.

To change the ID Masking value, first choose the ID Masking option in the menu and using the + or - switches, either increase or decrease it to the number you have determined. Please keep in mind that certain metals, other than the ones you are masking, will also be lost or their signal strength will diminish resulting in loss of depth.

For example; when you set the ID Masking to 40, the device will ignore all signals with IDs less than 40 and will not produce a warning tone. The device will also miss targets under rocks of which the received IDs are less than 40.

To give another example, in the case of receiving multiple IDs - let's say 35 and 55 - due to target orientation or metal property, if you mask the IDs up to 40, 35 will fall in the masked range so the signal strength may diminish and depth may decrease.

IMPORTANT! In general objects such as knives or pocketknives, guns and manhole covers all contain iron. Therefore, you should be careful when using the ID Masking feature. As the ID Masking value increases, the device's detection depth for these objects will decrease.

PINPOINT

Pinpointing is to determine the center or the exact location of a detected target.

FORS Tech operates on the principle of motion. This means that you must move the search coil over the target or the target over the search coil, in order for the device to detect it. In the pinpoint mode, however, the device constantly gives signal when you hold the search coil still over the target.

A proper ground balance setting is a must for accurate pinpointing. In changing ground conditions, re-ground balancing is recommended before pinpointing.

When you press and hold the pinpoint button, a horizontal bar moving in the negative or positive direction, indicating metal or soil/rock effects, appears on the LCD panel. The bar starts filling up as the target is approached. The furthest point it fills up to indicates the center of the target.

At the same time, the estimated depth reading appears on the LCD panel as well as the numeric display on the handle (see page 25). The signal tone increases in pitch and volume as the search coil approaches the target. In the pinpoint mode, the device does not discriminate or give target IDs. If the device is in the vibration mode, the speed of vibration will increase as you get closer to the center of target.

To pinpoint:

1. After a target is detected, move the search coil aside where there is no target response and press the pinpoint button.
2. Keeping the button pressed, approach the target with the search coil keeping it parallel to the ground.
3. As the center of the target is approached, the signal tone will get stronger and change in pitch. At the same time, the depth reading on the screen will start decreasing.
4. Mark the spot where you get the loudest response with your foot or an object.
5. Change your direction 90° and repeat the above steps. Repeating this process from a few different angles will narrow the field of detection and give you a better idea of target location.

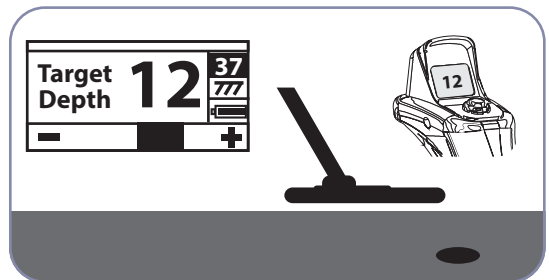
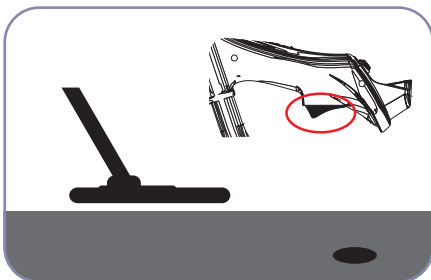

DEPTH INDICATION

The device gives an estimated depth reading based on signal strength in the pinpoint mode. When the pinpoint button is pressed and the target is approached, the depth reading will appear in "cm." on the LCD panel and the numeric display simultaneously.

Approximate depth is provided based on the assumption that the target is a typical modern coin. The real depth will vary based on target size. The device will give a greater depth reading for smaller targets and for larger targets, the depth reading will be smaller than they really are. In fact, pinpointing is used for target location and not depth indication. Therefore, we suggest that you use the depth reading for judging the proximity of the target.

SWEEP SPEED and TARGET IDENTIFICATION

FORS Tech is a very fast responding detector. When you detect a target with the FORS Tech, in order to get an accurate ID of the target, instead of narrowing the sweeps and making quick sweeps over the target like in other detectors, you should make wider and deliberate sweeps. If the sweep speed is wrong, the device cannot identify the target accurately and the IDs may bounce around. In addition, when you are sweeping the search coil, pay attention not to tilt it up or down and always keep it parallel to the ground.

LARGE or SHALLOW TARGETS

Shallow targets may give multiple responses to the device. If you suspect a shallow target, lift the search coil and sweep slowly until you get a single response. Similarly, large targets (manhole covers, pipes etc.) may cause an overload in the search coil and the device may give an alarm sounding like a siren. At the same time "Overload" message will appear on the LCD panel. In such a situation, raise the search coil until the message disappears.

FALSE SIGNALS and COMMON CAUSES

Sometimes the device may receive signals although there is no real target. There are a few different causes for this. Most common ones are ground mineralization or hot rocks, electromagnetic interference in the surrounding environment, operation of another detector nearby, rusty iron and corroded foil, and sensitivity and threshold set too high.

The electromagnetic interference can be eliminated by reducing sensitivity. If another detector is working nearby, you can change your location and continue your search. For ground mineralization or hot rocks, and sensitivity and threshold set too high, please read the related sections. (Ground Balance, Hot Rocks and Searching In Rocky Areas, Sensitivity and Threshold).

MAGNETIC MINERALIZATION LEVEL



Magnetic Mineralization level ranges from 0-99 and is displayed in the Magnetic Mineralization Indicator on the right side of the main screen. This measurement can be summarized as the amount of the magnetic property and intensity of the ground. Simply, if you are working on a ground with intense and magnetic minerals, this value will

be high. If the ground has low magnetic intensity, this value will be small.

This measurement is important from two aspects. First, detection depth is low in areas with high magnetic mineralization and the user should be aware of this fact. Second, magnetic mineralization is a property also found in hot rocks and measuring its level will play an important role for the device to eliminate false signals caused by hot rocks.

HOT ROCKS and SEARCHING IN ROCKY AREAS

Hot rocks are classified as negative or positive based on their ID being low or high in comparison to the ID of the soil they are in. One or both of the types may be present in a field. The negative and positive effects mentioned here will only be valid if ground balancing is properly done on the existing ground. Otherwise, soil itself will not act differently from hot rocks in terms of ID. In "Ground Tracking" however, conditions will differ. Therefore, the effects of hot rocks in "Ground Tracking" will be discussed separately. Here we are referring to a proper ground balance without "Ground Tracking".

Positive hot rocks act and sound just like metals. In the General Search mode, when you sweep the search coil over them, they tend to give a short "zip zip" sound. If the signal is strong enough, the device may also give an ID for these rocks. Negative hot rocks, on the other hand, tend to give a longer "boing" sound when the search coil is swept over them. The device will not give an ID for these rocks regardless of the signal strength.

In discrimination modes, positive hot rocks will give a typical metal sound again. Negative hot rocks will not give any sound in these modes (except for occasional false signals).

Therefore, while searching in the field, you can decide by listening to the warning tones emitted by the device. If you get a metal tone, it means that you have either detected a metal or a positive hot rock. If you get a strong signal and a stable ID, you can determine whether it is a hot rock or a metal by looking at the ID. Please keep in mind though weaker signals tend to give different IDs and metals under rocks may produce different metal signals. Consequently, digging up a target signal is the best option.

If you are using the discrimination modes and know the IDs of the hot rocks around you, you can use ID masking to eliminate these rocks. However, this may not be sufficient to avoid all rock signals. The device may still receive signals from rocks because soil and hot rocks together will form a combined effect and generate a different ID than those of rocks.

EFFECTS OF HOT ROCKS IN GROUND TRACKING

When the ground tracking is active, the device may give a warning tone and ID when it passes over a hot rock because the effect of the hot rock will be different than the ground's. If you sweep the search coil over the rock, ground tracking will automatically adjust the setting and the warning tone/ID will either disappear or diminish significantly. Because there is a slight delay in ground tracking, you may hear a strong signal at the first one or two sweeps until the setting is adjusted. Then the sound will get weaker and disappear. This will not happen with metal targets because metals will prevent the device from ground balancing. Therefore, in ground tracking, if you are getting a constant signal over a target after repeated sweeps, there is a high possibility that the target is a metal. Moving from over a hot rock back to soil, the device may give signals to the ground for a few sweeps until the ground balance setting is updated again. This is normal and should not mislead you.

Under normal circumstances, ground tracking should not be used for elimination of hot rocks. It is recommended for use in areas with changing soil types.

SEARCHING IN SHALLOW WATER AND ON THE BEACH

FORS Tech search coils are all waterproof. This provides convenient searching in shallow water and on beach. If searching around water, be careful not to get the system box or the handle wet.

As mentioned before, salty water or alkali ground are highly conductive and they create iron effects on detectors. FORS Tech Conductive Ground mode (COG) is specifically designed for these types of ground. You can easily search with the COG mode without any other settings.

COG mode is ideal for wet sand beach. When searching on dry sand, you can also use the other modes.

Please remember the following when searching in water or on wet beach sand:

- 1) You can get metal signals when you sweep the search coil over the holes you dig on wet beach sand, this is normal.
- 2) The search coil may give false signals when going into and coming out of the water so please try to keep the coil either in or out of the water.

IMPORTANT! Because the ID Masking value of the COG mode is preset to 40 to eliminate ferrous metals or ground effects due to iron mineralization, you may change the search mode or set the ID Masking below 40 if you are searching for ferrous metals.

MESSAGES

At the bottom of the LCD panel, on the main screen, messages will appear if any. If there is no message, the present search mode name will be displayed. Messages that may appear are as follows:

OVERLOAD:

It appears simultaneously with the overload warning alarm sounding like a siren. This happens when the search coil encounters a shallow or a very large object. The device will revert back to normal operation if you lift the coil up. If the alarm and the message continues along a long line, you may be over a long metal such as a pipe.

PUMP THE COIL:

It appears when the ground balance button is held pressed for automatic ground balancing. It does not indicate any issues or errors. It just tells you what to do.

COIL NOT CONNECTED:

It indicates an interruption in the search coil transmitter signal. The search coil connector may be unattached, loose or disconnected. If you own another detector with the same coil connector, please be sure that you have not attached the wrong coil by mistake. If none of the above exists, the search coil or its cable may have a defect. If the issue continues when you change the search coil, there may be an issue in the coil control circuit.

LOW BATTERY:

This message appears when the battery level drops below a certain point. The device may continue to work a few more hours. Meanwhile, please change the batteries.

FACTORY and STARTUP SETTINGS

The technical settings of the device (Mode, Ground Balance, Sensitivity, Threshold, and ID Masking, Frequency) come with their factory default values at each startup. Personal settings (Volume, Tone, Vibration, Brightness, and Language) come with the last adjusted value when the device is turned off and on again.

You can customize and save your startup settings by following the steps below:

1. Go to the menu screen and be sure that all the options are at the desired setting.
2. Wait and exit the menu.
3. On the main screen, press and hold one of the up or down switches for at least 4 seconds. The menu screen will appear; do not let go of the switch!
4. Keeping the switch pressed, press the '-' (minus) button. "Please wait" message will appear on screen. You can let go of the switches.
5. Wait while the message is on screen. In about 4-6 seconds, the process will finish and the menu screen will come up. It is normal for the device to emit different sounds during this process.
6. Turn off and on the device again. Go to the menu to check whether your desired startup settings are saved or not.

Changing the startup settings do not mean changing the factory default settings. You can restore factory defaults at any time. This process is done the same way. The only difference is that you use the '+' switch instead of '-'

1. Be sure that you have exited the menu and you are in the main screen.
2. On the main screen, press and hold one of the up or down switches for at least 4 seconds. The menu screen will appear; do not let go of the switch!
3. Keeping the switch pressed, press the '+' (plus) switch. "Please wait" message will appear on screen. You can let go of the switches.
4. Wait while the message is on screen. In about 4-6 seconds, the process will finish and the menu screen will come up. It is normal for the device to emit different sounds during this process.
5. Turn off and on the device again. Go to the menu and be sure that the factory defaults are restored.

TECHNICAL SPECIFICATIONS

Operating Principle	:	VLF Induction Balance
Operating Frequency	:	15 Khz (+/- 100 Hz bandwidth)
Metal Identification	:	Motion, multi-derivative
Search Modes	:	4 (General/Discrimination 2 & 3/ Conductive Ground)
Audio Frequencies	:	5
Audio Discrimination	:	3 tones
Ground Balance	:	Auto and Manual
Ground Tracking	:	Yes
Pinpoint	:	Yes
Frequency Shift	:	Yes
Vibration	:	Yes
Sensitivity Range	:	1-99
Target ID Range	:	0-99
Search Coil	:	28.5x17.8 cm (11.2"x 7.0") waterproof DD
Weight	:	1.8 kg (3.9 lbs.) including batteries and search coil
Length	:	125-150 cm (4'2"-5') extendable
Battery	:	4 AA Alkaline
Warranty	:	2 years

Nokta Detectors reserves the right to change the design, specifications or accessories without notice and without any obligation or liability whatsoever.